



INSTALLATION AND OPERATION MANUAL

ESP SERIES

POWER AMPLIFIER ES2120P



IMPORTANT SAFETY INFORMATION

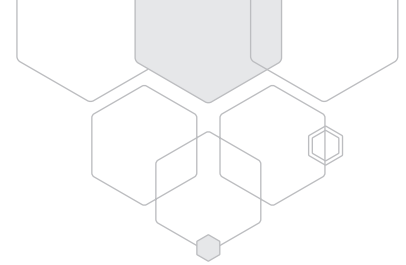

1. Read these instructions.
2. Keep these instructions.
3. Heed all warnings.
4. Follow all instructions.
5. Do not use this apparatus near water.
6. Clean only with dry cloth.
7. Do not block any ventilation openings. Install in accordance with the manufacturer's instructions.
8. Do not install near any heat sources such as radiators, heat registers, stoves, or other apparatus (including amplifiers) that produce heat.
9. Do not defeat the safety purpose of the polarized or grounding-type plug. A polarized plug has two blades with one wider than the other. A grounding type plug has two blades and a third grounding prong. The wide blade or the third prong are provided for your safety. If the provided plug does not fit into your outlet, consult an electrician for replacement of the obsolete outlet.
10. Protect the power cord from being walked on or pinched particularly at plugs, convenience receptacles, and the point where they exit from the apparatus.
11. Only use attachments/accessories specified by the manufacturer.
12. Use only with the cart, stand, tripod, bracket, or table specified by the manufacturer, or sold with the apparatus. When a cart is used, use caution when moving the cart/apparatus combination to avoid injury from tip-over.
13. Unplug this apparatus during lightning storms or when unused for long periods of time.
14. Refer all servicing to qualified service personnel. Servicing is required when the apparatus has been damaged in any way, such as power supply cord or plug is damaged, liquid has been spilled or objects have fallen into the apparatus, the apparatus has been exposed to rain or moisture, does not operate normally, or has been dropped.
15. This appliance shall not be exposed to dripping or splashing water and that no object filled with liquid such as vases shall be placed on the apparatus.
16. Plug this apparatus to the proper wall outlet and make the plug to be disconnected readily operable.
17. Mainsplug is used as disconnected device and it should remain readily operable during intended use. In order to disconnect the apparatus from the mains completely, the mains plug should be disconnected from the mains socket outlet completely.
18. **WARNING:** To reduce the risk of fire or electric shock, do not expose this apparatus to rain or moisture.
19. An appliance with a protective earth terminal should be connected to a mains outlet with a protective earth connection.
20. The apparatus should be disconnected from the mains completely before speaker wiring. The speaker output should be proper protected from direct contact and pay attention to speaker connections, terminals and speaker wiring during normal operation.



PRÉCAUTIONS DURANT UTILISATION

1. LISEZ ces instructions.
2. Tenez ces instructions.
3. Notez tous les avertissements.
4. Suivez toutes les avertissements.
5. N'utilisez pas ce produit près de l'eau (la piscine, la plage, le lac, etc.).
6. Nettoyez seulement avec une étoffe sèche.
7. Ne bloquez aucuns trous de ventilation. Installez en accord avec les instructions du fabricant.
8. N'installez près aucunes sources de chaleur comme radiateurs, registres de chaleur, fours ou les autres équipements (y compris ampli cateurs) qui produisent la chaleur.
9. Ne défaites pas le but de sécurité de la fiche polarisée ou base-type. Une fiche polarisée a deux tranchants avec un plus large que l'autre. Une fiche de base type a deux a deux tranchants et une troisième pointe de base, le tranchant large ou la troisième pointe est fourni pour votre sécurité. Si la fiche donnée ne conforme pas votre prise de contact, consultez un électricien pour remplacement de la prise de contact obsolète.
10. Protegez le cordon de secteur contre être marchée dessus ou pincez en particulier aux fiches, aux douilles de convenance, et au point où ils sortent de l'appareil.
11. Seulement utilisez attachements/accessoires spécifiés par le fabricant.
12. Utilisez seulement avec un chariot, un stand, un trépied, un support ou une table indiquée par le fabricant, ou vendue avec l'appareil. Quand un chariot est utilisé, faites attention en déplaçant la combinaison d'appareil/chariot pour éviter de se déséquilibrer.
13. Arrachez la fiche du dispositif durant éclair et orage ou quand pas utilisé pour longues périodes de temps.
14. Référéz au personnel qualifié de service pour toutes réparations. La réparation est donnée quand le système a été endommagé à n'importe façon, par exemple un fil ou une fiche endommagé(e) de la source d'alimentation. Avoir été exposé à pluie ou humidité, n'opère pas normalement, ou avoir été tombé.
15. L'appareil ne doit pas être exposé aux écoulements ou aux éclaboussures et aucun objet ne contenant de liquide, tel qu'un vase, ne doit être placé sur l'objet.
16. Branchez l'appareil à une source appropriée et faire que la prise à débrancher soit facilement accessible.
17. La prise du secteur ne doit pas être obstruée ou doit être facilement accessible pendant son utilisation. Pour être complètement déconnecté de l'alimentation d'entrée, la prise doit être débranchée du secteur.
18. **AVERTISSEMENT:** Pour éviter le risque d'incendie ou de chocs électriques, ne pas exposer cet appareil à la pluie ou à l'humidité.
19. Un appareil avec la borne de terre de protection doit être connecté au secteur avec la connexion de terre de protection.
20. Assurez-vous que l'appareil est hors tension avant de connecter les hauts parleurs. Veri ez que la sortie des enceintes soit protégées contre un contact physique. Respecter les polarités des terminaux ainsi que le câblage des enceintes pendant le fonctionnement afin d'assurer une utilisation sécurisée.



INTRODUCTION & CONTENTS

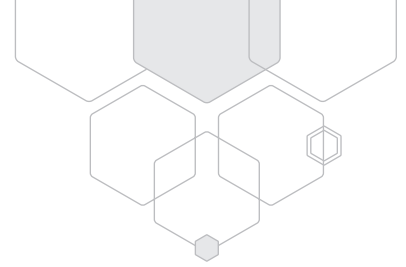

ESP SERIES

Congratulations on choosing Australian Monitor for your professional amplification requirements.

The ES2120P is a 2RU 2 channel 120W amplifier. This amplifier features 100V line and 4Ω output.

The Australian Monitor ESP series gives the contractor a low cost solution in applications that are price sensitive but still require a high quality of sound reproduction and reliability.

Introduction	3
Features & Protection Features	4
Front Panel	5
Rear Panel	6
Installation	7
Troubleshooting	8
Dimensions	9
Specifications	10

Revision 1.3: May 2021

WARNING

TO PREVENT FIRE OR SHOCK HAZARD, DO NOT USE THE PLUG WITH AN EXTENSION CORD, RECEPTACLE OR OTHER OUTLET UNLESS THE BLADES CAN BE FULLY INSERTED TO PREVENT BLADE EXPOSURE.

TO REDUCE THE RISK OF FIRE OR ELECTRIC SHOCK, DO NOT EXPOSE THIS APPLIANCE TO RAIN OR MOISTURE.

TO PREVENT ELECTRICAL SHOCK, MATCH WIDE BLADE PLUG TO WIDE SLOT AND FULLY INSERT.

CAUTION

THESE SERVICING INSTRUCTIONS ARE FOR USE BY QUALIFIED SERVICE PERSONNEL ONLY. TO REDUCE THE RISK OF ELECTRIC SHOCK DO NOT PERFORM ANY SERVICING OTHER THAN THAT CONTAINED IN THE OPERATING INSTRUCTIONS UNLESS YOU ARE QUALIFIED TO DO SO.



The lightning flash with arrowhead symbol, within an equilateral triangle, is intended to alert the user to the presence of uninsulated "dangerous voltage" within the product's enclosure that may be of sufficient magnitude to constitute a risk of electric shock to persons.



WARNING

TO REDUCE THE RISK OF ELECTRIC SHOCK, DO NOT REMOVE COVER (OR BACK). NO USER SERVICEABLE PARTS INSIDE. REFER SERVICING TO QUALIFIED SERVICE PERSONNEL.



The exclamation point within an equilateral triangle is intended to alert the user to the presence of important operating and maintenance (servicing) instructions in the literature accompanying the appliance



For European Union countries: This symbol on the product or its packaging indicates that this product must not be disposed of with other waste. Instead, it is your responsibility to dispose of your waste equipment by handing it over to a designated collection point for the recycling of waste electrical and electronic equipment. Please contact your local authority for further details of your nearest designated collection point.

Rating plate and caution marking are marked on the back enclosure of the apparatus

FEATURES & PROTECTION FEATURES

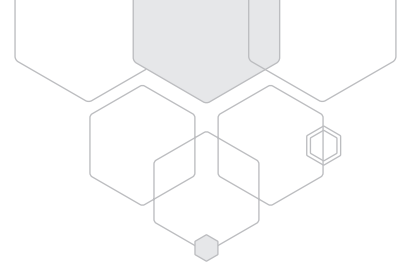

FEATURES

- ES2120P - 2 x 120W
- 100V and 4Ω outputs
- XLR Through Output
- Level Adjustment
- 2 RU

PROTECTION FEATURES

- Short-circuit protection
- Over load protection
- Thermal protection

ES2120P AMPLIFIER BLOCK DIAGRAM

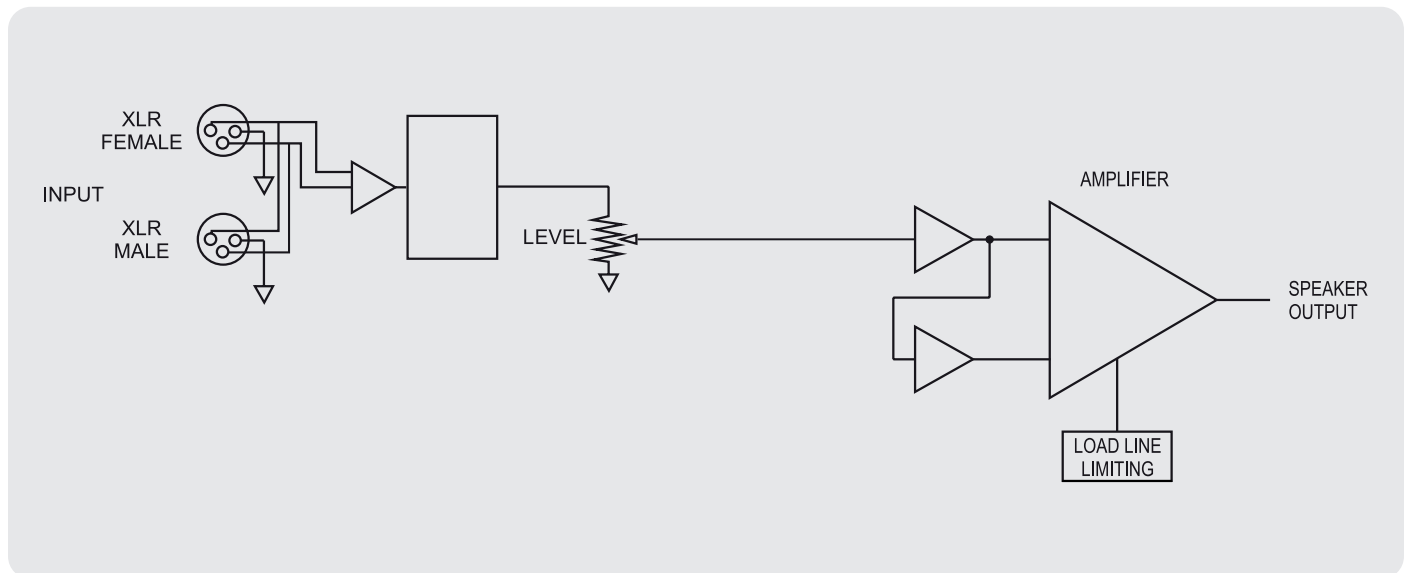

FRONT PANEL

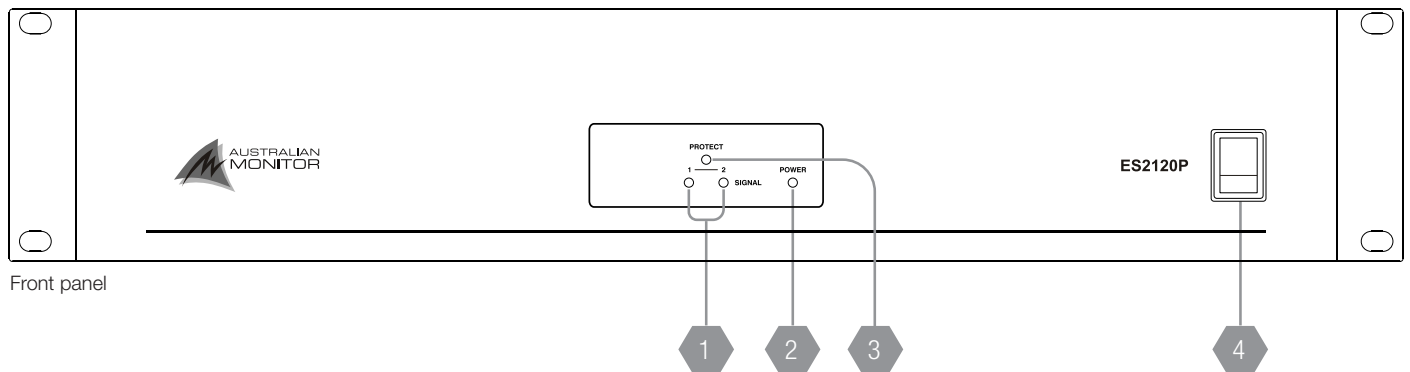
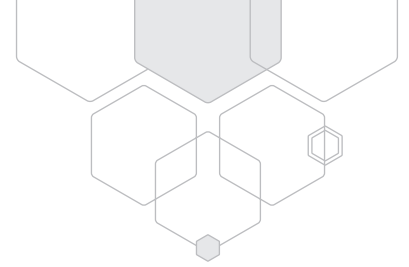

Front panel

- 1** **SIGNAL**
This LED indicates the unit is outputting a signal.

- 2** **POWER**
This LED indicates the unit is on.

- 3** **PROTECTION**
This LED indicates that the amplifier is protection due to a short circuit or overload condition at the output terminals.

- 4** **POWER SWITCH**
This switches the power to the unit on and off. The up position is on.

REAR PANEL

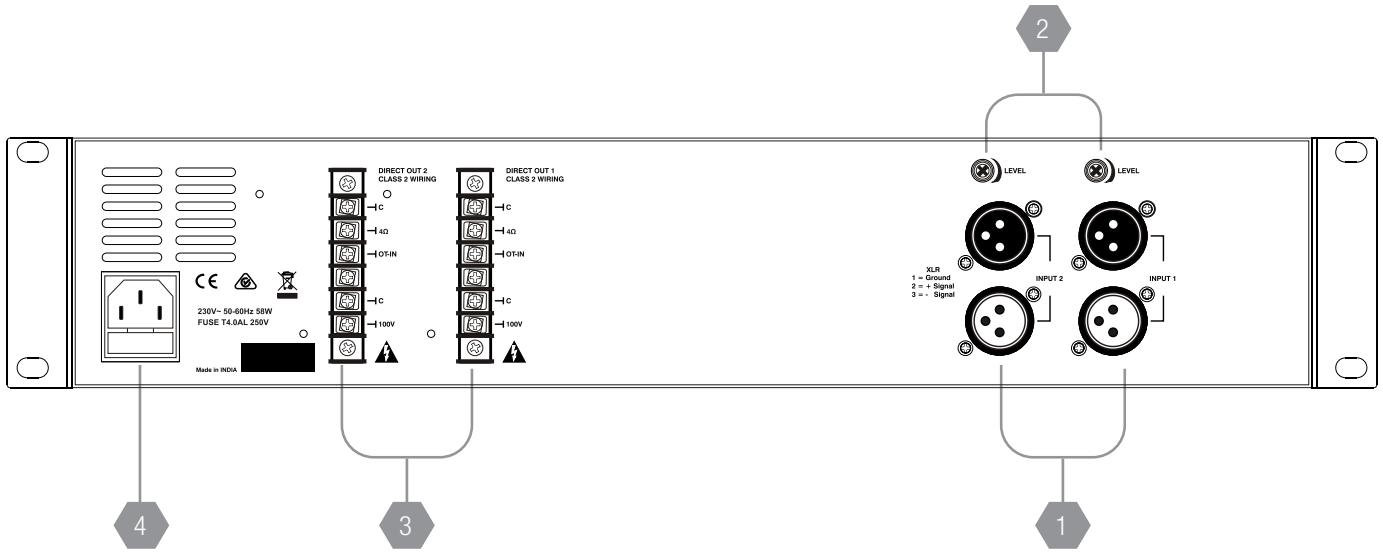

1

INPUT

These 3 pin XLR sockets accept the source input for each channel. One input is a male XLR, the other is a female XLR. The male XLR is normally used as a thru output. When wiring from unbalanced sources, pins 1 and 3 should be shorted together. The input sensitivity (voltage required to drive amplifier to maximum power) of the amplifier is 150mV with the Input Level Control set at maximum.

2

LEVEL

This potentiometer controls the level of the signal through the amplifier channel. Minimum position is Off and maximum gives a sensitivity of 150mV. The input level control should be run above the 12 o'clock position (half way) to avoid clipping the input stage.

3

SPEAKER OUTPUT

Speaker connections are provided on screw terminals. 4Ω low impedance and 100V. **IMPORTANT:** If you are using the 100V output you must connect the jumper link between 4Ω and OT-IN

MINIMUM IMPEDANCE	ES2120P
DISTRIBUTED LINE OUTPUT 100V	83Ω
LOW IMPEDANCE OUTPUT	4Ω

NOTE: Only connect one output – either 4Ω or 100V. Do not connect 4Ω and 100V at the same time.

4

IEC MAINS INPUT SOCKET

This is a standard IEC 60320-C14 socket. It accepts a standard IEC mains cable, provided. The fuse drawer contains the mains fuse and a spare. Consult the specification section for fuse ratings.

- Always replace the fuse with one of the same value and type.
- Always disconnect power to the amplifier before replacing fuses.

INSTALLATION



POWER REQUIREMENTS

Power consumption for your model of the ESP Series amplifier is indicated on the rear panel for 1/8th output power. Ensure that your mains voltage is the same as the rear panel mains voltage marker ($\pm 10\%$).

MOUNTING

The ESP Series amplifiers are two rack units high (2U) and will fit a standard EIA 19" or rack. Typically amplifiers may be stacked directly on top of each other with no need for spacing between units, unless installed in high ambient temperature environments where a single rack unit space between amplifiers will assist cooling further.

COOLING

The power amplifiers are cooled by axial fans which draw air inside the amplifier and expel the heated air outside the amplifier. An unrestricted airflow into and out from the amplifier must be provided. Any restriction of the air flow will cause heat to build up within the unit and possibly force the unit into its thermal shutdown mode.

If the amplifiers are to be operated in an environment where the airflow is restricted such as sealed racks, cooling should be supplemented by extra cooling fans to evacuate the heated air and aid the flow of cool air through the unit.

OUTPUT WIRING

When wiring to your speakers always use the largest gauge wire your connector will accept. The longer the speaker lead the greater the losses which will result in reduced power and less damping at the load. We recommend using a heavy duty, two core flex (four core flex if bi-amping) 10 to 12 gauge (2mm² to 2.5mm² or 50/0.25 or equivalent) as a minimum.

SPEAKER OUTPUT

The output terminal strip accepts wire sizes from 16-22AWG (1.5mm² – 0.35mm²) or spade lugs. The following table should be used as a guideline for cable sizes. Regulations in your area may require different gauged wire and should be checked before using.

OUTPUT	DISTANCE	
100V	Upto 50m	AWG24(0.2mm ²)
	50m - 200m	AWG18(0.75mm ²)
	Over 200m	AWG16(1.5mm ²)
4Ω	Upto 10m	AWG18(0.75mm ²)
	10m - 30m	AWG13(2.5mm ²)
	Over 30m	Not Recommended

NOTE: Only connect one output – either 100V or 4Ω

INPUT CONNECTIONS

When wiring balanced inputs, wire the male plug so that it mates with the female XLR on the back of the amplifier. Follow the pin outs listed in the diagram below.

When wiring as a unbalanced input, wire the male plug so that it mates with the female XLR on the back of the amplifier. Connect Cold- to Gnd as there is no cold signal available in an unbalanced connection.

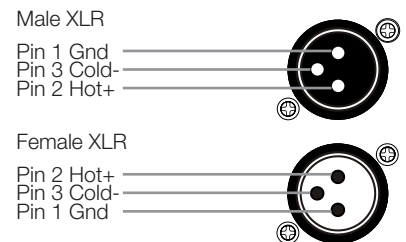
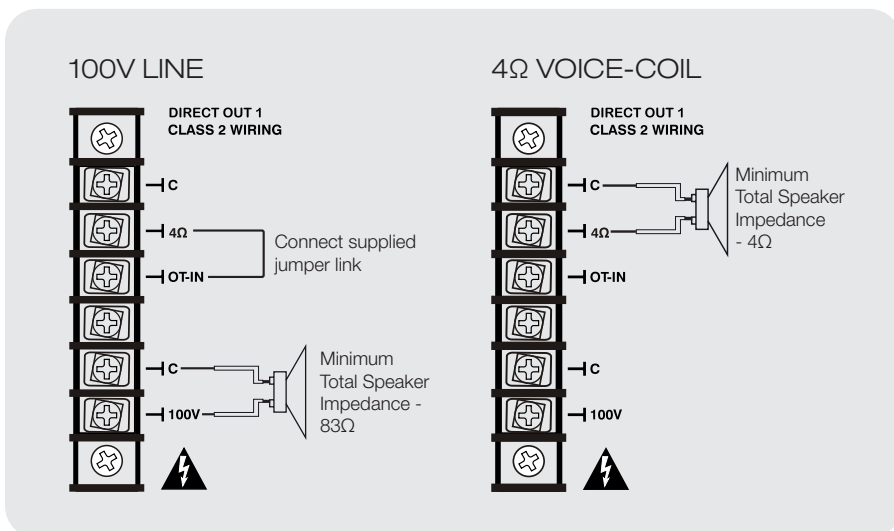

TROUBLESHOOTING

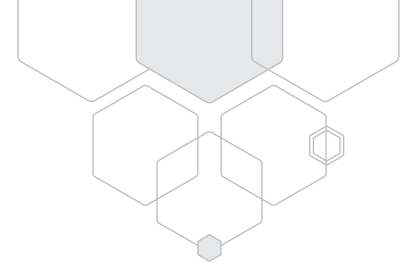

TROUBLE	LIKELY CAUSE	REMEDY
Power LED not on	Power not reaching amplifier	Check power switch is on Check mains connection Check mains fuse
Distorted sound	Output is short circuit	Check speaker loads for shorts
	Input is overloaded	Reduce input level at source
	Output is being over driven	Reduce volume levels on rear panel
No sound but amplifier is on	Volume controls down	Check volume controls
	Amplifier has overheated	Check for obstructions above and below Make sure the amplifier is well ventilated

DIMENSIONS

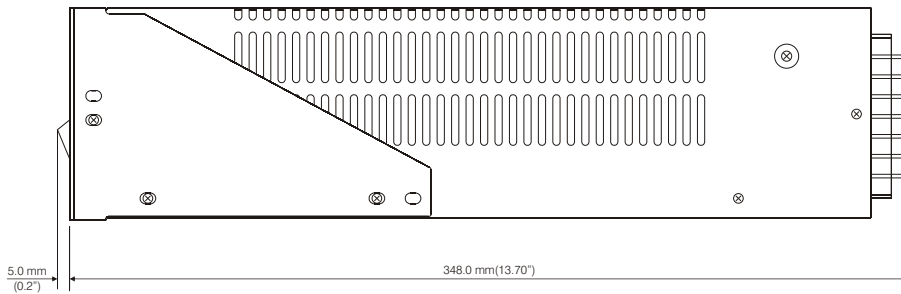
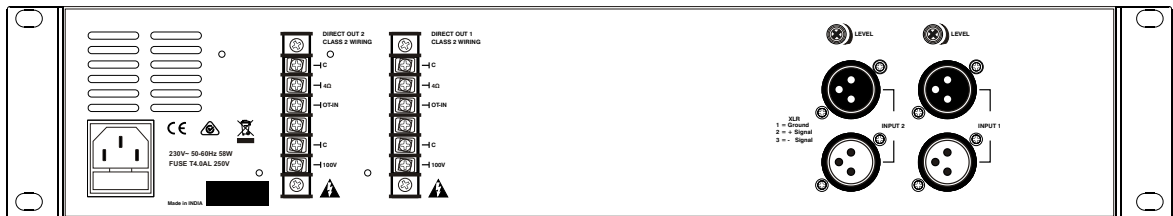
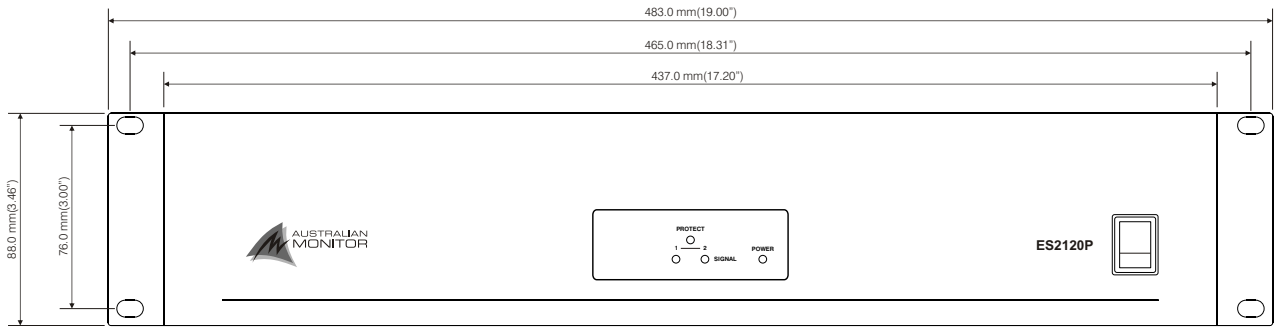
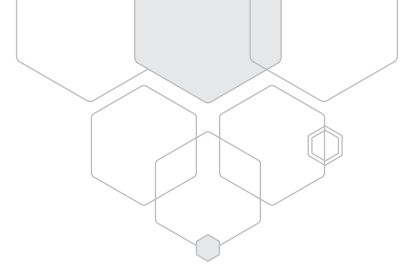

SPECIFICATIONS

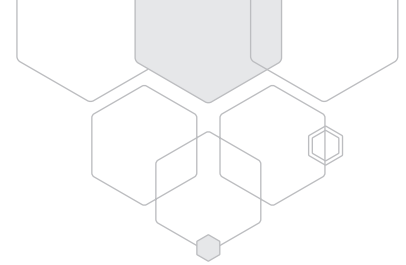

Model	OUTPUT 1	OUTPUT 2	Conditions/Comments
AUDIO OUTPUT			
4Ω (SINGLE CHANNEL DRIVEN) 4Ω (BOTH CHANNEL DRIVEN) 100V (SINGLE CHANNEL DRIVEN) 100V (BOTH CHANNEL DRIVEN)	133W/158mV 130W/156mV 126W/157mV 125W/158mV	131W/160mV 128W/158mV 123W/159mV 121W/158mV	1kHz. 1%THD. -5W/+5W
MAX OUTPUT LEVEL (DBV/ VRMS)	22.6V	22.6V	4Ω Output. 150mV
SYSTEM GAIN	44dB	44dB	4Ω, 150mV
FREQUENCY RESPONSE 4Ω FREQUENCY RESPONSE 100V	14Hz ~ 34kHz 90Hz ~ 30kHz	15Hz ~ 34kHz 90Hz ~ 30kHz	3dB below clipping, +0/-3dB.±5Hz 3dB below clipping, +0/-3dB.±5Hz Low Frequency ±2kHz High Frequency
SIGNAL TO NOISE RATIO 4Ω SIGNAL TO NOISE RATIO 100V	91dB/150mV 91dB/150mV	90dB/150mV 90dB/150mV	Pot Wound Max, Max Output, 1kHz, A-Weighted
THD+N. 4Ω. 1kHz THD+N. 4Ω. FREQ. BAND THD+N. 100V. 1kHz THD+N. 100V. FREQ BAND	0.01% 0.14% 0.03% 0.05%	0.01% 0.14% 0.04% 0.05%	3dB below clipping, 1kHz. A-Weighted 3dB below clipping, Freq Band. 20kHz BW, A-Weighted 3dB below clipping, 1kHz. A-Weighted 3dB below clipping, Freq Band. 20kHz BW, A-Weighted
AUDIO SENSITIVITY			
AUDIO INPUT SENSITIVITY	150mV	150mV	Rated Power, 100V Output
NO LOAD VOLT.4Ω	22.5V		4Ω
LOADED VOLT 4Ω	22.1V		4Ω
LED SIGNAL	-34dBr		
AUDIO MISCELLANEOUS			
INPUT IMPEDANCE	20kΩ		
INPUT CMRR	> 57dBr		

SPECIFICATIONS CONT.

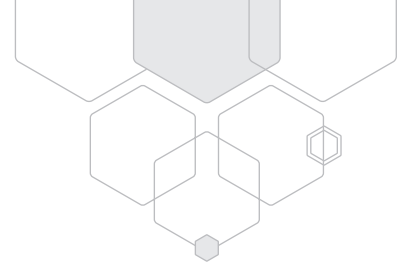

Model	OUTPUT 1	OUTPUT 2	Conditions/Comments
POWER REQUIREMENTS			
AC INPUT	230Vac, 50-60Hz		±10%
AC POWER FACTOR	> 0.55		
AC INPUT CONNECTOR	IEC 60320-C14		
AC MAINS FUSE	4A SB glass		
MAXIMUM INRUSH CURRENT	60A		
RMS CURRENT DRAW IDLE 1/8TH POWER 1/3RD POWER FULL POWER	0.1A 0.4A 1.0A 2.3A		230V AC, 50Hz, 100V Output, 1kHz, Sine
POWER CONSUMPTION IDLE 1/8TH POWER 1/3RD POWER FULL POWER	11W 58W 124W 334W		230V AC, 50Hz, 100V Output, 1kHz, Sine
EFFICIENCY 1/8TH POWER 1/3RD POWER FULL POWER	67% 71% 74%		230V AC, 50Hz, 100V Output, 1kHz, Sine
THERMAL DISSIPATION IDLE 1/8TH POWER 1/3RD POWER FULL POWER	38 188 413 1110		Excludes Load Power (1W = 3.412BTU/Hr)
MISCELLANEOUS			
PRODUCT DIMENSIONS (WITH RACK EARS) PRODUCT DIMENSIONS (WITHOUT RACK EARS)	483mm x 353mm x 88mm (19.02" W x 13.9" D x 3.46" H) 437mm x 353mm x 88mm (17.20" W x 13.9" D x 3.46" H)		
SHIPPING DIMENSIONS	556mm x 471mm x 171mm (21.9" W x 18.5" D x 6.7" H)		
NET WEIGHT	7.45 Kg (16.43 lb)		
SHIPPING WEIGHT	8.8 Kg (19.40 lb)		
MOUNTING	2RU		
OPERATING TEMPERATURE	0°C to 40°C (95% RH)		
FINISH	Powder Coated Steel		
COLOUR	Black (Satin)		
ACCESSORIES	IEC Mains cable, Rubber Feet x 4		
APPROVALS	CE, IEC, RCM		

Due to continuous improvements, all specifications are subject to change



ENGINEERED BY AUSTRALIAN MONITOR

Address: Unit 1, 2 Daydream Street, Warriewood NSW 2102 Australia

Website: www.australianmonitor.com.au

International enquiries email: international@australianmonitor.com.au

ABN 86 003 231 187